



Is Now Part of



ON Semiconductor®

To learn more about ON Semiconductor, please visit our website at www.onsemi.com

Please note. As part of the Fairchild Semiconductor integration, some of the Fairchild orderable part numbers will need to change in order to meet ON Semiconductor's system requirements. Since the ON Semiconductor product management systems do not have the ability to manage part nomenclature that utilizes an underscore (_), the underscore (_) in the Fairchild part numbers will be changed to a dash (-). This document may contain device numbers with an underscore (_). Please check the ON Semiconductor website to verify the updated device numbers. The most current and up-to-date ordering information can be found at www.onsemi.com. Please email any questions regarding the system integration to Fairchild_questions@onsemi.com.

ON Semiconductor and the ON Semiconductor logo are trademarks of Semiconductor Components Industries, LLC dba ON Semiconductor or its subsidiaries in the United States and/or other countries. ON Semiconductor owns the rights to a number of patents, trademarks, copyrights, trade secrets, and other intellectual property. A listing of ON Semiconductor's product/patent coverage may be accessed at www.onsemi.com/site/pdf/Patent-Marking.pdf. ON Semiconductor reserves the right to make changes without further notice to any products herein. ON Semiconductor makes no warranty, representation or guarantee regarding the suitability of its products for any particular purpose, nor does ON Semiconductor assume any liability arising out of the application or use of any product or circuit, and specifically disclaims any and all liability, including without limitation special, consequential or incidental damages. Buyer is responsible for its products and applications using ON Semiconductor products, including compliance with all laws, regulations and safety requirements or standards, regardless of any support or applications information provided by ON Semiconductor. "Typical" parameters which may be provided in ON Semiconductor data sheets and/or specifications can and do vary in different applications and actual performance may vary over time. All operating parameters, including "Typicals" must be validated for each customer application by customer's technical experts. ON Semiconductor does not convey any license under its patent rights nor the rights of others. ON Semiconductor products are not designed, intended, or authorized for use as a critical component in life support systems or any FDA Class 3 medical devices or medical devices with a same or similar classification in a foreign jurisdiction or any devices intended for implantation in the human body. Should Buyer purchase or use ON Semiconductor products for any such unintended or unauthorized application, Buyer shall indemnify and hold ON Semiconductor and its officers, employees, subsidiaries, affiliates, and distributors harmless against all claims, costs, damages, and expenses, and reasonable attorney fees arising out of, directly or indirectly, any claim of personal injury or death associated with such unintended or unauthorized use, even if such claim alleges that ON Semiconductor was negligent regarding the design or manufacture of the part. ON Semiconductor is an Equal Opportunity/Affirmative Action Employer. This literature is subject to all applicable copyright laws and is not for resale in any manner.

74LVT162244 • 74LVTH162244

Low Voltage 16-Bit Buffer/Line Driver with 3-STATE Outputs and 25Ω Series Resistors in the Outputs

General Description

The LVT162244 and LVTH162244 contain sixteen non-inverting buffers with 3-STATE outputs designed to be employed as a memory and address driver, clock driver, or bus oriented transmitter/receiver. The device is nibble controlled. Individual 3-STATE control inputs can be shorted together for 8-bit or 16-bit operation.

The LVT162244 and LVTH162244 are designed with equivalent 25Ω series resistance in both the HIGH and LOW states of the output. This design reduces line noise in applications such as memory address drivers, clock drivers, and bus transceivers/transmitters.

The LVTH162244 data inputs include bushold, eliminating the need for external pull-up resistors to hold unused inputs.

These buffers and line drivers are designed for low (3.3V) V_{CC} applications, but with the capability to provide TTL interface to a 5V environment. The LVT162244 and LVTH162244 are fabricated with an advanced BiCMOS technology to achieve high speed operation similar to 5V ABT while maintaining a low power consumption.

Features

- Input and output interface capability to systems 5V V_{CC}
- Bushold data inputs eliminate the need for external pull-up resistors to hold unused inputs (LVTH162244), also available without bushold feature (LVT162244).
- Live insertion/contact permission
- Power-on power-down impedance provides glitch-free bus operation
- Outputs include equivalent series resistance of 25.2 to make external termination resistors unnecessary and reduce overshoot and undershoot
- Functionally compatible with the 74 Series 162244
- Switch-up performance exceeds 500 mA
- ESD performance:
 - Human-body model > 2000V
 - Machine model > 200V
 - Charged-device > 1000V
- Also packaged in plastic Fine-Pitch Ball Grid Array (FBGA)

Ordering Code:

Order Number	Package Number	Package Description
74LVT162244G (Note 1)(Note 2)	BGA54A	54-Ball Fine-Pitch Ball Grid Array (FBGA), JEDEC MO-205, 5.5mm Wide
74LVT162244MEA (Note 2)	MS48A	48-Lead Small Shrink Outline Package (SSOP), JEDEC MO-118, 0.300" Wide
74LVT162244MTD (Note 2)	MTD48	48-Lead Thin Shrink Small Outline Package (TSSOP), JEDEC MO-153, 6.1mm Wide
74LVTH162244G (Note 1)(Note 2)	BGA54A	54-Ball Fine-Pitch Ball Grid Array (FBGA), JEDEC MO-205, 5.5mm Wide
74LVTH162244MEA	MS48A	48-Lead Small Shrink Outline Package (SSOP), JEDEC MO-118, 0.300" Wide [Tube]
74LVTH162244MEX	MS48A	48-Lead Small Shrink Outline Package (SSOP), JEDEC MO-118, 0.300" Wide [Tape and Reel]
74LVTH162244MTD	MTD48	48-Lead Thin Shrink Small Outline Package (TSSOP), JEDEC MO-153, 6.1mm Wide [Tube]
74LVTH162244MTX	MTD48	48-Lead Thin Shrink Small Outline Package (TSSOP), JEDEC MO-153, 6.1mm Wide [Tape and Reel]

Note 1: Ordering code "G" indicates Trays.

Note 2: Devices also available in Tape and Reel. Specify by appending the suffix letter "X" to the ordering code.

74LVT162244 • 74LVTH162244 Low Voltage 16-Bit Buffer/Line Driver with 3-STATE Outputs and 25Ω Series Resistors in the Outputs

Logic Symbol

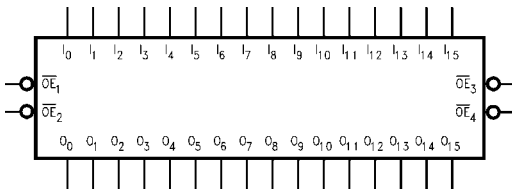

Pin Descriptions

Pin Names	Description
\overline{OE}_n	Output Enable Inputs (Active LOW)
I_0-I_{15}	Inputs
O_0-O_{15}	Outputs
NC	No Connect

Connection Diagrams

Pin Assignment for SSOP and TSSOP

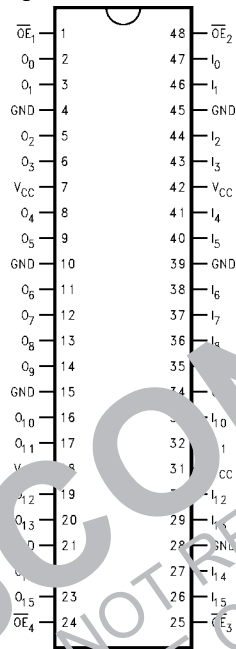

Pin Assignment for FBGA

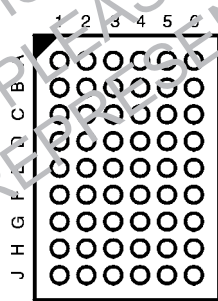

(Top Thru View)

FBGA Pin Assignments

	1	2	3	4	5	6
A	O ₀	NC	\overline{OE}_1	\overline{OE}_2	NC	I ₀
B	O ₂	O ₁	NC	NC	I ₁	I ₂
C	O ₄	O ₃	NC	NC	I ₃	I ₄
D	O ₆	O ₅	GND	GND	I ₅	I ₆
E	O ₈	O ₇	GND	GND	I ₇	I ₈
F	O ₁₀	O ₉	NC	GND	I ₉	I ₁₀
G	O ₁₂	O ₁₁	VCC	VCC	I ₁₁	I ₁₂
H	O ₁₄	O ₁₃	NC	NC	I ₁₃	I ₁₄
J	O ₁₅	NC	\overline{OE}_4	\overline{OE}_3	NC	I ₁₅

Truth Table

Inputs		Outputs
\overline{OE}_1	I ₀ -I ₃	O ₀ -O ₃
L	L	L
L	H	H
H	X	Z
\overline{OE}_2	I ₄ -I ₇	O ₄ -O ₇
L	L	L
L	H	H
H	X	Z
\overline{OE}_3	I ₈ -I ₁₁	O ₈ -O ₁₁
L	L	L
L	H	H
H	X	Z
\overline{OE}_4	I ₁₂ -I ₁₅	O ₁₂ -O ₁₅
L	L	L
L	H	H
H	X	Z

H = HIGH Voltage Level L = LOW Voltage Level
Z = High Impedance X = Immaterial

Functional Description

The LVT162244 and LVTH162244 contain sixteen non-inverting buffers with 3-STATE outputs. The device is nibble (4 bits) controlled with each nibble functioning identically, but independent of the other. The control pins can be shorted together to obtain full 16-bit operation.

Logic Diagram

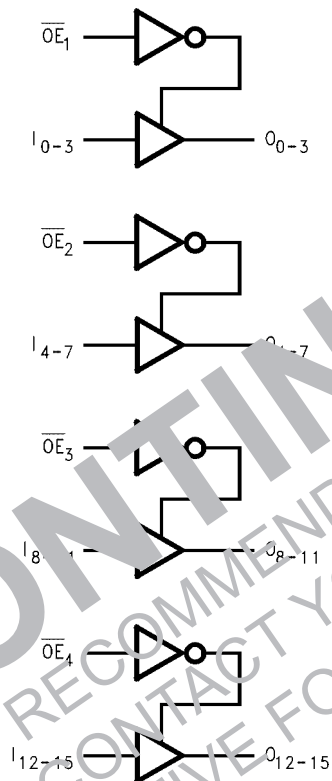

DISCONTINUED
THIS DEVICE IS NOT RECOMMENDED FOR NEW DESIGN
PLEASE CONTACT YOUR onsemi
REPRESENTATIVE FOR INFORMATION

Absolute Maximum Ratings (Note 3)

Symbol	Parameter	Value	Conditions	Units
V_{CC}	Supply Voltage	-0.5 to +4.6		V
V_I	DC Input Voltage	-0.5 to +7.0		V
V_O	Output Voltage	-0.5 to +7.0	Output in 3-STATE	V
		-0.5 to +7.0	Output in HIGH or LOW State (Note 4)	
I_{IK}	DC Input Diode Current	-50	$V_I < GND$	mA
I_{OK}	DC Output Diode Current	-50	$V_O < GND$	mA
I_O	DC Output Current	64	$V_O > V_{CC}$ Output at HIGH State	mA
		128	$V_O > V_{CC}$ Output at LOW State	
I_{CC}	DC Supply Current per Supply Pin	±64		mA
I_{GND}	DC Ground Current per Ground Pin	±128		mA
T_{STG}	Storage Temperature	-65 to +150		°C

Recommended Operating Conditions

Symbol	Parameter	Min	Max	Units
V_{CC}	Supply Voltage	2.7	3.6	V
V_I	Input Voltage		5.5	V
I_{OH}	HIGH-Level Output Current		-12	mA
I_{OL}	LOW-Level Output Current		12	mA
T_A	Free Air Operating Temperature	-40	+85	°C
$\Delta t/\Delta V$	Input Edge Rate, $V_{IN} = 0.8V-2.0V$, $V_{CC} = 3.0V$		10	ns/V

Note 3: Absolute Maximum continuous ratings are the values beyond which damage to the device may occur. Exposure to these conditions or conditions beyond those indicated may adversely affect device performance. Normal operation under absolute maximum rated conditions is not implied.

Note 4: I_O Absolute Maximum Rating is per device.

DC Electrical Characteristics

Symbol	Parameter	V_{CC} (V)	$T_A = -40^\circ C$ to $+35^\circ C$		Units	Conditions	
			Min	Max			
V_{IK}	Input Clamp Diode Voltage	2.7		-1.2	V	$I_I = -18$ mA	
V_{IH}	Input HIGH Voltage	2.7-3.6	2.0		V	$V_O \leq 0.1V$ or $V_O \geq V_{CC} - 0.1V$	
V_{IL}	Input LOW Voltage	2.7-3.6		0.8	V		
V_{OH}	Output HIGH Voltage	2.7-3.6	$V_{CC}-0.2$		V	$I_{OH} = -100$ μA	
		3.0	2.0			$I_{OH} = -12$ mA	
V_{OL}	Output LOW Voltage	2.7		0.2	V	$I_{OL} = 100$ μA	
		3.0		0.8		$I_{OL} = 12$ mA	
$I_{I(HOLD)}$ (Note 5)	Bushold Input Minimum Drive	3.0	75		μA	$V_I = 0.8V$	
			-75			$V_I = 2.0V$	
$I_{I(O)}$ (Note 5)	Bushold Input Over-Drive Current to Change State	3.0	500		μA	(Note 6)	
			-500			(Note 7)	
I_I	Input Current	3.6		10	μA	$V_I = 5.5V$	
		Control Pins	3.6			±1	$V_I = 0V$ or V_{CC}
		Data Pins	3.6			-5	$V_I = 0V$
I_{OFF}	Power Off Leakage Current	0		±100	μA	$0V \leq V_I$ or $V_O \leq 5.5V$	
$I_{PU/PD}$	Power Up/Down				μA	$V_O = 0.5V$ to $3.0V$	
	3-STATE Current	0-1.5V		±100	μA	$V_I = GND$ or V_{CC}	
I_{OZL}	3-STATE Output Leakage Current	3.6		-5	μA	$V_O = 0.5V$	
I_{OZH}	3-STATE Output Leakage Current	3.6		5	μA	$V_O = 3.0V$	
I_{OZH+}	3-STATE Output Leakage Current	3.6		10	μA	$V_{CC} < V_O \leq 5.5V$	
I_{CCH}	Power Supply Current	3.6		0.19	mA	Outputs HIGH	
I_{CCL}	Power Supply Current	3.6		5	mA	Outputs LOW	
I_{CCZ}	Power Supply Current	3.6		0.19	mA	Outputs Disabled	

DC Electrical Characteristics (Continued)

Symbol	Parameter	V _{CC} (V)	T _A = -40°C to +85°C		Units	Conditions
			Min	Max		
I _{CCZ} ⁺	Power Supply Current	3.6		0.19	mA	V _{CC} ≤ V _O ≤ 5.5V, Outputs Disabled
ΔI _{CC}	Increase in Power Supply Current (Note 8)	3.6		0.2	mA	One Input at V _{CC} - 0.6V Other Inputs at V _{CC} or GND

Note 5: Applies to bushold versions only (74LVTH162244).

Note 6: An external driver must source at least the specified current to switch from LOW-to-HIGH.

Note 7: An external driver must sink at least the specified current to switch from HIGH-to-LOW.

Note 8: This is the increase in supply current for each input that is at the specified voltage level rather than V_{CC} or GND.

Dynamic Switching Characteristics (Note 9)

Symbol	Parameter	V _{CC} (V)	T _A = 25°C			Units	Conditions V _I = 0V, R _L = 50Ω (Note 10)
			Min	Typ	Max		
V _{OLP}	Quiet Output Maximum Dynamic V _{OL}	3.3		0.8	V	(Note 10)	
V _{OLV}	Quiet Output Minimum Dynamic V _{OL}	3.3		-0.8	V	(Note 10)	

Note 9: Characterized in SSOP package. Guaranteed parameter, but not tested.

Note 10: Max number of outputs defined as (n), n-1 data inputs are driven 0V to 3V, Output current is 10mA.

AC Electrical Characteristics

Symbol	Parameter	T _A = -40°C to +85°C, C _L = 50 pF, R _L = 500Ω				Units
		V _I = 3.3V ± 0.3V		V _{CC} = 2.7V		
		Min	Max	Min	Max	
t _{PLH}	Propagation Delay Data to output	1.4	4.0	1.4	1.8	ns
t _{PHL}		1.2	3.7	1.2	4.1	ns
t _{PZH}	Output Enable	1.2	5.1	1.2	6.5	ns
t _{PZL}		1.4	5.4	1.4	6.9	ns
t _{PHZ}	Output Disable Time	2.0	5.0	2.0	5.4	ns
t _{PLZ}		1.5	5.0	1.5	5.4	ns
t _{OSHL}	Output Skew (Low)		1.0		1.0	ns
t _{OSLH}	Output Skew (High) (Note 11)		1.0		1.0	ns

Note 11: Skew is defined as the absolute value of the difference between the actual propagation delay for any two separate outputs of the same device. The specification applies to any outputs switching in the same direction, either HIGH-to-LOW (t_{OSHL}) or LOW-to-HIGH (t_{OSLH}).

Capacitance (Note 12)

Symbol	Parameter	Conditions	Typical	Units
C _{IN}	Input Capacitance	V _{CC} = 0V, V _I = 0V or V _{CC}	4	pF
C _{OUT}	Output Capacitance	V _{CC} = 3.0V, V _O = 0V or V _{CC}	8	pF

Note 12: Capacitance is measured at a frequency f = 1 MHz, per MIL-STD-883, Method 3012.

Physical Dimensions inches (millimeters) unless otherwise noted

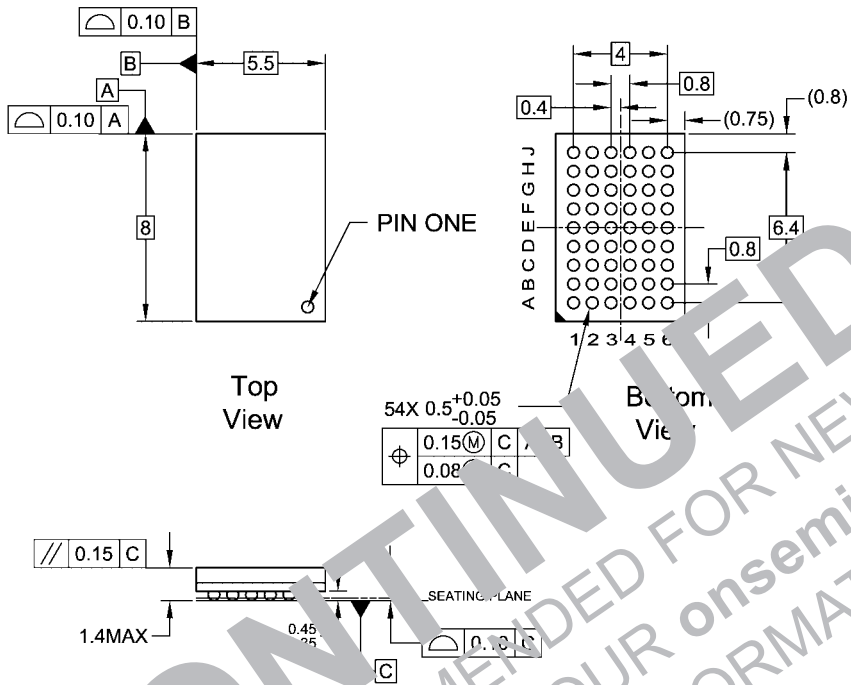

NOTES:

- A. THIS PACKAGE CONFORMS TO JEDEC MO-205
- B. ALL DIMENSIONS IN MILLIMETERS
- C. LUMINA CORPORATION RECOMMENDATION, NSMD (Non Solder Mask Defined)
- D. 0.35mm DIA PADS WITH A SOLDER MASK OPENING OF .45MM CONCENTRIC TO PADS
- E. DRAWING CONFORMS TO ASME Y14.5M-1994

BGA54A revD

54-Ball Fine-Pitch Ball Grid Array (FBGA), JEDEC MO-205, 5.5mm Wide
Package Number BGA54A

Physical Dimensions inches (millimeters) unless otherwise noted (Continued)

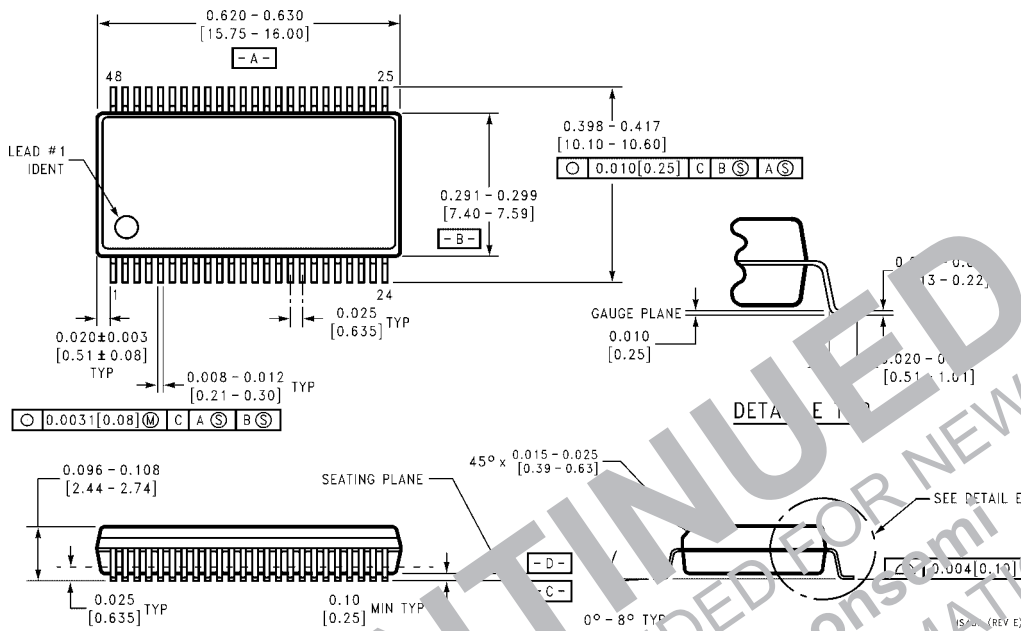

48-Lead Small Shrink Package (SSOP), JEDEC MO-118, 0.400" Wide
 Package Number MS-8A

DISCONTINUED
 THIS DEVICE IS NOT RECOMMENDED FOR NEW DESIGN
 PLEASE CONTACT YOUR ONSEMI REPRESENTATIVE FOR INFORMATION

Physical Dimensions inches (millimeters) unless otherwise noted (Continued)

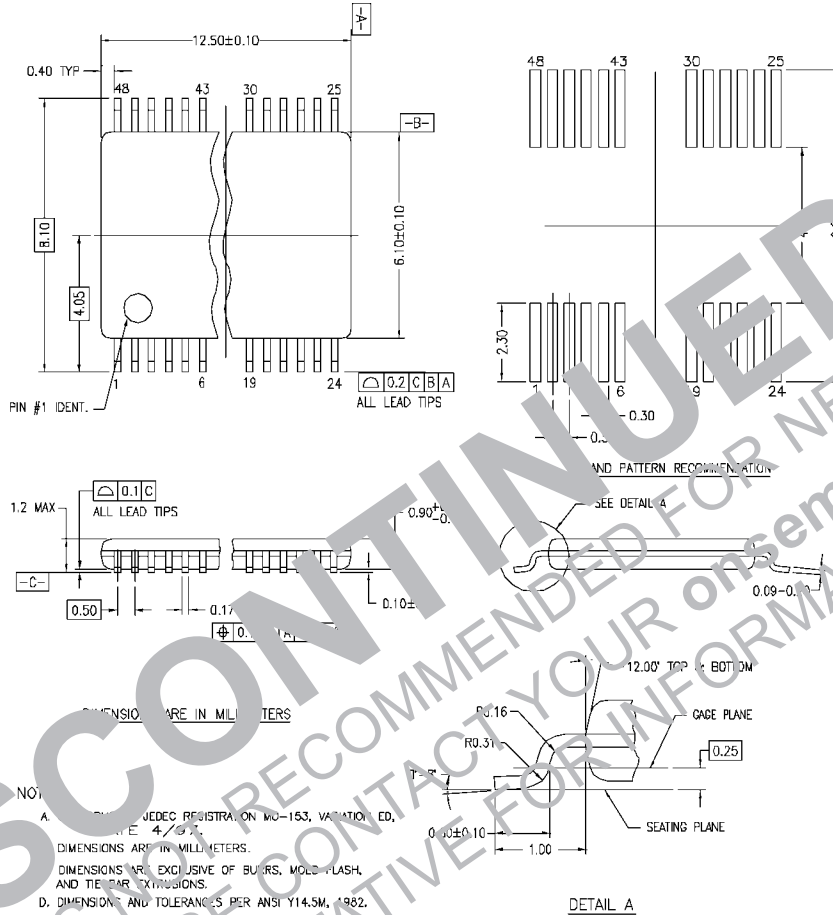

NOTES:
 A. DIMENSIONS ARE IN MILLIMETERS.
 B. DIMENSIONS ARE EXCLUSIVE OF BURRS, MOLD FLASH, AND TIE BAR EXTENSIONS.
 C. DIMENSIONS AND TOLERANCES PER ANSI Y14.5M, 1982.
 MTD48REV C

4-Lead Thin Shrink Small Outline Package (TSSOP), JEDEC MO-153, 6.1mm Wide Package Number MTD48

Fairchild does not assume any responsibility for use of any circuitry described, no circuit patent licenses are implied and Fairchild reserves the right at any time without notice to change said circuitry and specifications.

LIFE SUPPORT POLICY

FAIRCHILD'S PRODUCTS ARE NOT AUTHORIZED FOR USE AS CRITICAL COMPONENTS IN LIFE SUPPORT DEVICES OR SYSTEMS WITHOUT THE EXPRESS WRITTEN APPROVAL OF THE PRESIDENT OF FAIRCHILD SEMICONDUCTOR CORPORATION. As used herein:

1. Life support devices or systems are devices or systems which, (a) are intended for surgical implant into the body, or (b) support or sustain life, and (c) whose failure to perform when properly used in accordance with instructions for use provided in the labeling, can be reasonably expected to result in a significant injury to the user.
2. A critical component in any component of a life support device or system whose failure to perform can be reasonably expected to cause the failure of the life support device or system, or to affect its safety or effectiveness.

www.fairchildsemi.com

DISCONTINUED
THIS DEVICE IS NOT RECOMMENDED FOR NEW DESIGN
PLEASE CONTACT YOUR onsemi
REPRESENTATIVE FOR INFORMATION

ON Semiconductor and  are trademarks of Semiconductor Components Industries, LLC dba ON Semiconductor or its subsidiaries in the United States and/or other countries. ON Semiconductor owns the rights to a number of patents, trademarks, copyrights, trade secrets, and other intellectual property. A listing of ON Semiconductor's product/patent coverage may be accessed at www.onsemi.com/site/pdf/Patent-Marking.pdf. ON Semiconductor reserves the right to make changes without further notice to any products herein. ON Semiconductor makes no warranty, representation or guarantee regarding the suitability of its products for any particular purpose, nor does ON Semiconductor assume any liability arising out of the application or use of any product or circuit, and specifically disclaims any and all liability, including without limitation special, consequential or incidental damages. Buyer is responsible for its products and applications using ON Semiconductor products, including compliance with all laws, regulations and safety requirements or standards, regardless of any support or applications information provided by ON Semiconductor. "Typical" parameters which may be provided in ON Semiconductor data sheets and/or specifications can and do vary in different applications and actual performance may vary over time. All operating parameters, including "Typicals" must be validated for each customer application by customer's technical experts. ON Semiconductor does not convey any license under its patent rights nor the rights of others. ON Semiconductor products are not designed, intended, or authorized for use as a critical component in life support systems or any FDA Class 3 medical devices or medical devices with a same or similar classification in a foreign jurisdiction or any devices intended for implantation in the human body. Should Buyer purchase or use ON Semiconductor products for any such unintended or unauthorized application, Buyer shall indemnify and hold ON Semiconductor and its officers, employees, subsidiaries, affiliates, and distributors harmless against all claims, costs, damages, and expenses, and reasonable attorney fees arising out of, directly or indirectly, any claim of personal injury or death associated with such unintended or unauthorized use, even if such claim alleges that ON Semiconductor was negligent regarding the design or manufacture of the part. ON Semiconductor is an Equal Opportunity/Affirmative Action Employer. This literature is subject to all applicable copyright laws and is not for resale in any manner.

PUBLICATION ORDERING INFORMATION

LITERATURE FULFILLMENT:

Literature Distribution Center for ON Semiconductor
19521 E. 32nd Pkwy, Aurora, Colorado 80011 USA
Phone: 303-675-2175 or 800-344-3860 Toll Free USA/Canada
Fax: 303-675-2176 or 800-344-3867 Toll Free USA/Canada
Email: orderlit@onsemi.com

N. American Technical Support: 800-282-9855 Toll Free
USA/Canada
Europe, Middle East and Africa Technical Support:
Phone: 421 33 790 2910
Japan Customer Focus Center
Phone: 81-3-5817-1050

ON Semiconductor Website: www.onsemi.com
Order Literature: <http://www.onsemi.com/orderlit>
For additional information, please contact your local
Sales Representative