

ON Semiconductor

Is Now

onsemi™

To learn more about onsemi™, please visit our website at
www.onsemi.com

onsemi and **onsemi** and other names, marks, and brands are registered and/or common law trademarks of Semiconductor Components Industries, LLC dba "**onsemi**" or its affiliates and/or subsidiaries in the United States and/or other countries. **onsemi** owns the rights to a number of patents, trademarks, copyrights, trade secrets, and other intellectual property. A listing of **onsemi** product/patent coverage may be accessed at www.onsemi.com/site/pdf/Patent-Marking.pdf. **onsemi** reserves the right to make changes at any time to any products or information herein, without notice. The information herein is provided "as-is" and **onsemi** makes no warranty, representation or guarantee regarding the accuracy of the information, product features, availability, functionality, or suitability of its products for any particular purpose, nor does **onsemi** assume any liability arising out of the application or use of any product or circuit, and specifically disclaims any and all liability, including without limitation special, consequential or incidental damages. Buyer is responsible for its products and applications using **onsemi** products, including compliance with all laws, regulations and safety requirements or standards, regardless of any support or applications information provided by **onsemi**. "Typical" parameters which may be provided in **onsemi** data sheets and/or specifications can and do vary in different applications and actual performance may vary over time. All operating parameters, including "Typicals" must be validated for each customer application by customer's technical experts. **onsemi** does not convey any license under any of its intellectual property rights nor the rights of others. **onsemi** products are not designed, intended, or authorized for use as a critical component in life support systems or any FDA Class 3 medical devices or medical devices with a same or similar classification in a foreign jurisdiction or any devices intended for implantation in the human body. Should Buyer purchase or use **onsemi** products for any such unintended or unauthorized application, Buyer shall indemnify and hold **onsemi** and its officers, employees, subsidiaries, affiliates, and distributors harmless against all claims, costs, damages, and expenses, and reasonable attorney fees arising out of, directly or indirectly, any claim of personal injury or death associated with such unintended or unauthorized use, even if such claim alleges that **onsemi** was negligent regarding the design or manufacture of the part. **onsemi** is an Equal Opportunity/Affirmative Action Employer. This literature is subject to all applicable copyright laws and is not for resale in any manner. Other names and brands may be claimed as the property of others.

MC74HCT245A

Octal 3-State Noninverting Bus Transceiver with LSTTL Compatible Inputs

High-Performance Silicon-Gate CMOS



ON Semiconductor®

<http://onsemi.com>

The MC74HCT245A is identical in pinout to the LS245. This device may be used as a level converter for interfacing TTL or NMOS outputs to High Speed CMOS inputs.

The MC74HCT245A is a 3-state noninverting transceiver that is used for 2-way asynchronous communication between data buses. The device has an active-low Output Enable pin, which is used to place the I/O ports into high-impedance states. The Direction control determines whether data flows from A to B or from B to A.

Features

- Output Drive Capability: 15 LSTTL Loads
- TTL/NMOS Compatible Input Levels
- Outputs Directly Interface to CMOS, NMOS and TTL
- Operating Voltage Range: 4.5 V to 5.5 V
- Low Input Current: 1.0 μ A
- In Compliance with the Requirements Defined by JEDEC Standard No. 7 A
- Chip Complexity: 304 FETs or 76 Equivalent Gates
- These Devices are Pb-Free and are RoHS Compliant

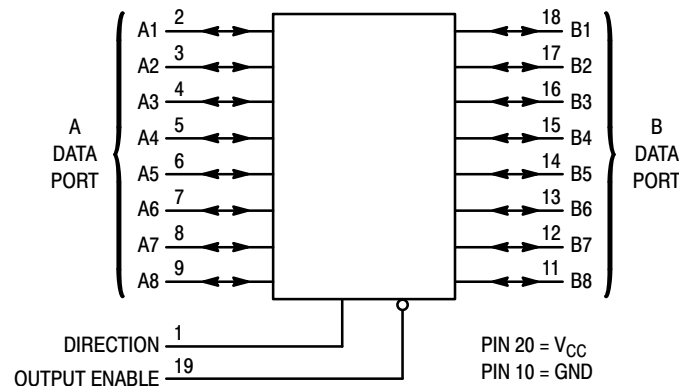

Figure 1. Logic Diagram

| Design Criteria | Value | Units |
|---------------------------------|-------|---------|
| Internal Gate Count* | 76 | ea |
| Internal Gate Propagation Delay | 1.0 | ns |
| Internal Gate Power Dissipation | 5.0 | μ W |
| Speed Power Product | 0.005 | pJ |

*Equivalent to a two-input NAND gate.

FUNCTION TABLE

| Control Inputs | | Operation |
|----------------|-----------|---------------------------------------|
| Output Enable | Direction | |
| L | L | Data Transmitted from Bus B to Bus A |
| L | H | Data Transmitted from Bus A to Bus B |
| H | X | Buses Isolated (High-Impedance State) |

X = Don't Care

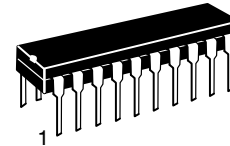

PDIP-20
N SUFFIX
CASE 738

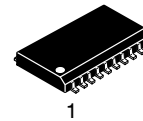

SOIC-20W
DW SUFFIX
CASE 751D

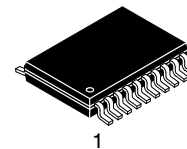

TSSOP-20
DT SUFFIX
CASE 948E

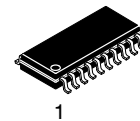

SOEIAJ-20
F SUFFIX
CASE 967

PIN ASSIGNMENT

| | | | |
|---------------|----|----|-----------------|
| DIRECTION | 1 | 20 | V _{CC} |
| OUTPUT ENABLE | 19 | | |
| A1 | 2 | 18 | B1 |
| A2 | 3 | 17 | B2 |
| A3 | 4 | 16 | B3 |
| A4 | 5 | 15 | B4 |
| A5 | 6 | 14 | B5 |
| A6 | 7 | 13 | B6 |
| A7 | 8 | 12 | B7 |
| A8 | 9 | 11 | B8 |
| GND | 10 | | |

ORDERING INFORMATION

See detailed ordering, shipping information, and marking information in the package dimensions section on page 6 of this data sheet.

MC74HCT245A

MAXIMUM RATINGS

| Symbol | Parameter | Value | Unit |
|-----------|---|-------------------------|------|
| V_{CC} | DC Supply Voltage (Referenced to GND) | - 0.5 to + 7.0 | V |
| V_{in} | DC Input Voltage (Referenced to GND) | - 0.5 to $V_{CC} + 0.5$ | V |
| V_{out} | DC Output Voltage (Referenced to GND) | - 0.5 to $V_{CC} + 0.5$ | V |
| I_{in} | DC Input Current, per Pin | ± 20 | mA |
| I_{out} | DC Output Current, per Pin | ± 35 | mA |
| I_{CC} | DC Supply Current, V_{CC} and GND Pins | ± 75 | mA |
| P_D | Power Dissipation in Still Air, PDIP† SOIC Package† TSSOP Package† | 750 500 450 | mW |
| T_{stg} | Storage Temperature | - 65 to + 150 | °C |
| T_L | Lead Temperature, 1 mm from Case for 10 Secs (PDIP, SOIC, SSOP or TSSOP Package) | 260 | °C |

This device contains protection circuitry to guard against damage due to high static voltages or electric fields. However, precautions must be taken to avoid applications of any voltage higher than maximum rated voltages to this high-impedance circuit. For proper operation, V_{in} and V_{out} should be constrained to the range $GND \leq (V_{in} \text{ or } V_{out}) \leq V_{CC}$. Unused inputs must always be tied to an appropriate logic voltage level (e.g., either GND or V_{CC}). Unused outputs must be left open.

Stresses exceeding Maximum Ratings may damage the device. Maximum Ratings are stress ratings only. Functional operation above the Recommended Operating Conditions is not implied. Extended exposure to stresses above the Recommended Operating Conditions may affect device reliability.

†Derating — Plastic DIP: - 10 mW/°C from 65° to 125°C
SOIC Package: - 7 mW/°C from 65° to 125°C
TSSOP Package: - 6.1 mW/°C from 65° to 125°C

RECOMMENDED OPERATING CONDITIONS

| Symbol | Parameter | Min | Max | Unit |
|-------------------|--|------|----------|------|
| V_{CC} | DC Supply Voltage (Referenced to GND) | 4.5 | 5.5 | V |
| V_{in}, V_{out} | DC Input Voltage, Output Voltage (Referenced to GND) | 0 | V_{CC} | V |
| T_A | Operating Temperature, All Package Types | - 55 | + 125 | °C |
| t_r, t_f | Input Rise and Fall Time (Figure 1) | 0 | 500 | ns |

MC74HCT245A

DC ELECTRICAL CHARACTERISTICS (Voltages Referenced to GND)

| Symbol | Parameter | Test Conditions | V _{CC} V | Guaranteed Limit | | | Unit |
|------------------|--|---|----------------------|------------------|---------------|------------|------|
| | | | | - 55 to 25°C | ≤ 85°C | ≤ 125°C | |
| V _{IH} | Minimum High-Level Input Voltage | V _{out} = 0.1 V or V _{CC} - 0.1 V I _{out} ≤ 20 μA | 4.5 5.5 | 2.0 2.0 | 2.0 2.0 | 2.0 2.0 | V |
| V _{IL} | Maximum Low-Level Input Voltage | V _{out} = 0.1 V or V _{CC} - 0.1 V I _{out} ≤ 20 μA | 4.5 5.5 | 0.8 0.8 | 0.8 0.8 | 0.8 0.8 | V |
| V _{OH} | Minimum High-Level Output Voltage | V _{in} = V _{IH} or V _{IL} I _{out} ≤ 20 μA | 4.5 5.5 | 4.4 5.4 | 4.4 5.4 | 4.4 5.4 | V |
| | | V _{in} = V _{IH} or V _{IL} I _{out} ≤ 6.0 mA | 4.5 | 3.98 | 3.84 | 3.7 | |
| V _{OL} | Maximum Low-Level Output Voltage | V _{in} = V _{IH} or V _{IL} I _{out} ≤ 20 μA | 4.5 5.5 | 0.1 0.1 | 0.1 0.1 | 0.1 0.1 | V |
| | | V _{in} = V _{IH} or V _{IL} I _{out} ≤ 6.0 mA | 4.5 | 0.26 | 0.33 | 0.4 | |
| I _{in} | Maximum Input Leakage Current | V _{in} = V _{CC} or GND, Pins 1 or 19 | 5.5 | ± 0.1 | ± 1.0 | ± 1.0 | μA |
| I _{CC} | Maximum Quiescent Supply Current (per Package) | V _{in} = V _{CC} or GND I _{out} = 0 μA | 5.5 | 4.0 | 40 | 160 | μA |
| I _{OZ} | Maximum Three-State Leakage Current | Output in High-Impedance State V _{in} = V _{IL} or V _{IH} V _{out} = V _{CC} or GND, I/O Pins | 5.5 | ± 0.5 | ± 5.0 | ± 10 | μA |
| ΔI _{CC} | Additional Quiescent Supply Current | V _{in} = 2.4 V, Any One Input V _{in} = V _{CC} or GND, Other Inputs I _{out} = 0 μA | 5.5 | ≥ -55°C | 25°C to 125°C | | mA |
| | | | | 2.9 | 2.4 | | |

AC ELECTRICAL CHARACTERISTICS (V_{CC} = 5.0 V ± 10%, C_L = 50 pF, Input t_r = t_f = 6.0 ns)

| Symbol | Parameter | Guaranteed Limit | | | Unit |
|--|--|---|--------|---------|------|
| | | - 55 to 25°C | ≤ 85°C | ≤ 125°C | |
| t _{PLH} , t _{PHL} | Maximum Propagation Delay, A to B or B to A (Figures 2 and 4) | 22 | 28 | 33 | ns |
| t _{PLZ} , t _{PHZ} | Maximum Propagation Delay, Direction or Output Enable to A or B (Figures 3 and 5) | 30 | 36 | 42 | ns |
| t _{PZL} , t _{PZH} | Maximum Propagation Delay, Output Enable to A or B (Figures 3 and 5) | 30 | 36 | 42 | ns |
| t _{TLH} , t _{THL} | Maximum Output Transition Time, any Output (Figures 2 and 4) | 12 | 15 | 18 | ns |
| C _{in} | Maximum Input Capacitance (Pin 1 or 19) | 10 | 10 | 10 | pF |
| C _{out} | Maximum Three-State I/O Capacitance, (I/O in High-Impedance State) | 15 | 15 | 15 | pF |
| C _{PD} | Power Dissipation Capacitance (Per Enabled Output)* | Typical @ 25°C, V _{CC} = 5.0 V | | | pF |
| | | 97 | | | |

* Used to determine the no-load dynamic power consumption: P_D = C_{PD} V_{CC}²f + I_{CC} V_{CC}.

MC74HCT245A

SWITCHING WAVEFORMS

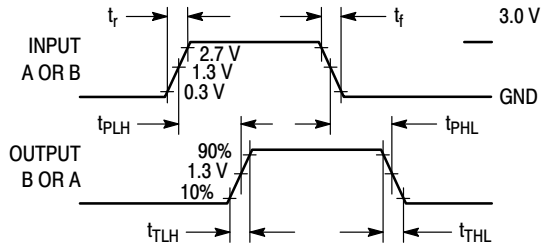

Figure 2.

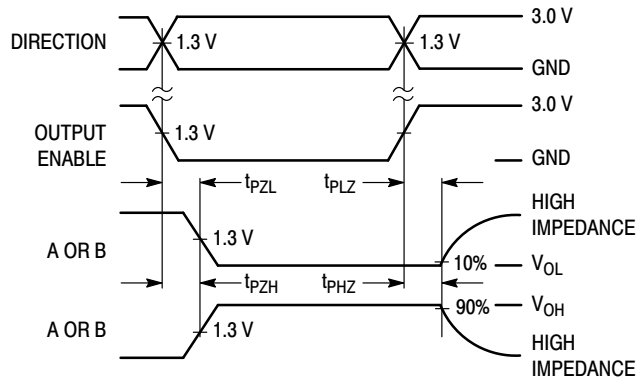
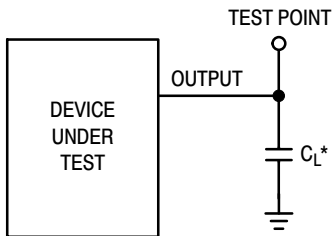
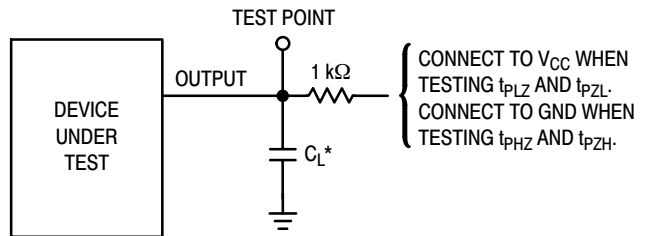

Figure 3.



*Includes all probe and jig capacitance

Figure 4.



*Includes all probe and jig capacitance

Figure 5. Test Circuit

MC74HCT245A

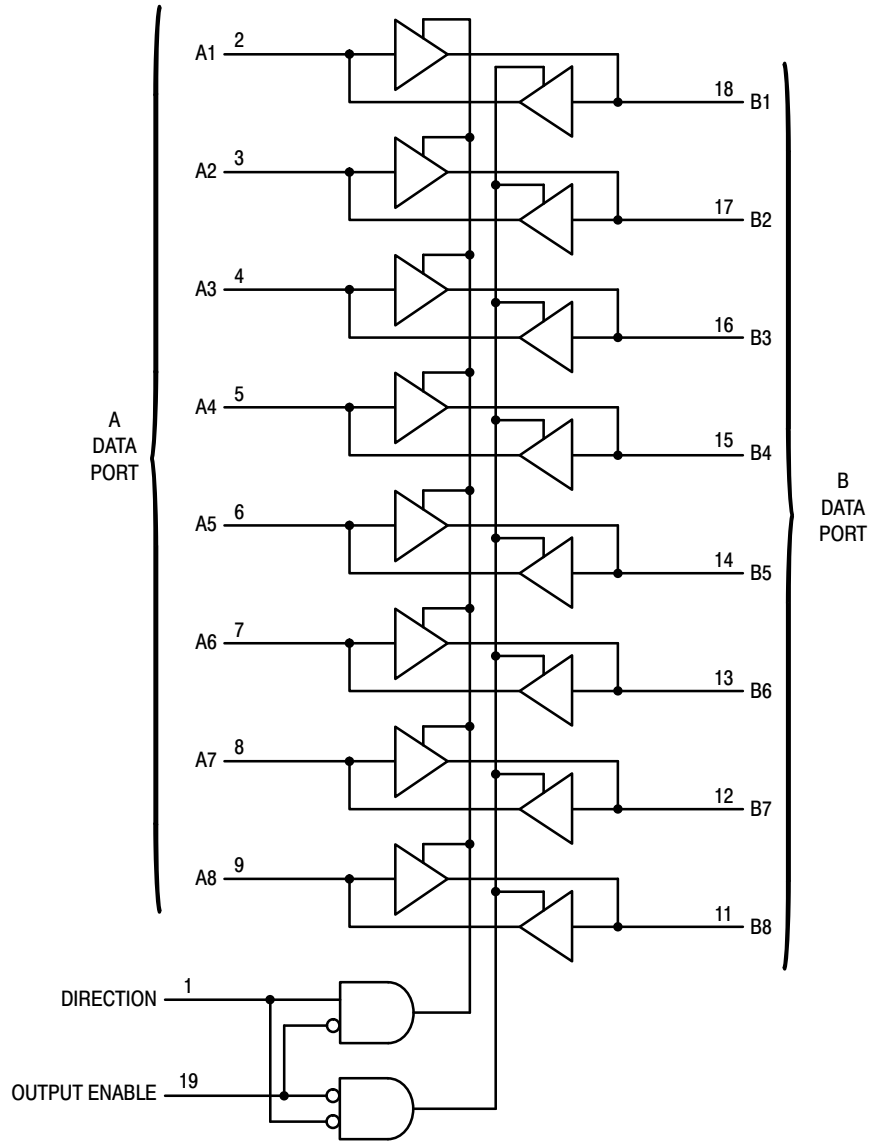

Figure 6. Expanded Logic Diagram

MC74HCT245A

ORDERING INFORMATION

| Device | Package | Shipping† |
|------------------|------------------------|--------------------|
| MC74HCT245ANG | PDIP-20 (Pb-Free) | 18 Units / Rail |
| MC74HCT245ADWG | SOIC-20 (Pb-Free) | 38 Units / Rail |
| MC74HCT245ADWR2G | SOIC-20 (Pb-Free) | 1000 / Tape & Reel |
| MC74HCT245ADTG | TSSOP-20* | 75 Units / Rail |
| MC74HCT245ADTR2G | TSSOP-20* | 2500 / Tape & Reel |
| MC74HCT245AFELG | SOEIAJ-20 (Pb-Free) | 2000 / Tape & Reel |

†For information on tape and reel specifications, including part orientation and tape sizes, please refer to our Tape and Reel Packaging Specifications Brochure, BRD8011/D.

*These packages are inherently Pb-Free.

MARKING DIAGRAMS

PDIP-20



SOIC-20W

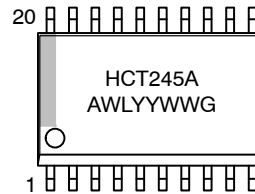

TSSOP-20

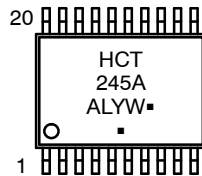

SOEIAJ-20

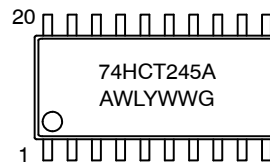

A = Assembly Location
 WL, L = Wafer Lot
 YY, Y = Year
 WW, W = Work Week
 G or ■ = Pb-Free Package
 (Note: Microdot may be in either location)

MC74HCT245A

PACKAGE DIMENSIONS

PDIP-20
N SUFFIX
PLASTIC DIP PACKAGE
CASE 738-03
ISSUE E

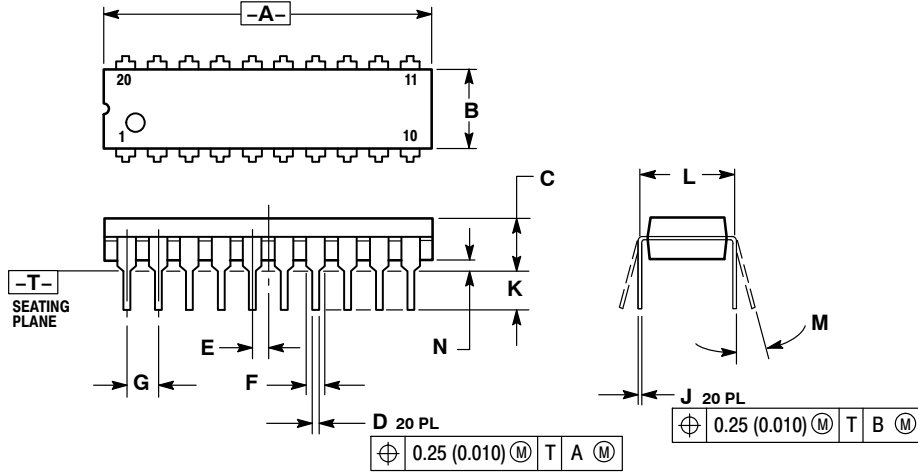

- NOTES:
1. DIMENSIONING AND TOLERANCING PER ANSI Y14.5M, 1982.
 2. CONTROLLING DIMENSION: INCH.
 3. DIMENSION L TO CENTER OF LEAD WHEN FORMED PARALLEL.
 4. DIMENSION B DOES NOT INCLUDE MOLD FLASH.

| DIM | INCHES | | MILLIMETERS | |
|-----|-----------|-------|-------------|-------|
| | MIN | MAX | MIN | MAX |
| A | 1.010 | 1.070 | 25.66 | 27.17 |
| B | 0.240 | 0.260 | 6.10 | 6.60 |
| C | 0.150 | 0.180 | 3.81 | 4.57 |
| D | 0.015 | 0.022 | 0.39 | 0.55 |
| E | 0.050 BSC | | 1.27 BSC | |
| F | 0.050 | 0.070 | 1.27 | 1.77 |
| G | 0.100 BSC | | 2.54 BSC | |
| J | 0.008 | 0.015 | 0.21 | 0.38 |
| K | 0.110 | 0.140 | 2.80 | 3.55 |
| L | 0.300 BSC | | 7.62 BSC | |
| M | 0° | 15° | 0° | 15° |
| N | 0.020 | 0.040 | 0.51 | 1.01 |

SOIC-20W
DW SUFFIX
CASE 751D-05
ISSUE G

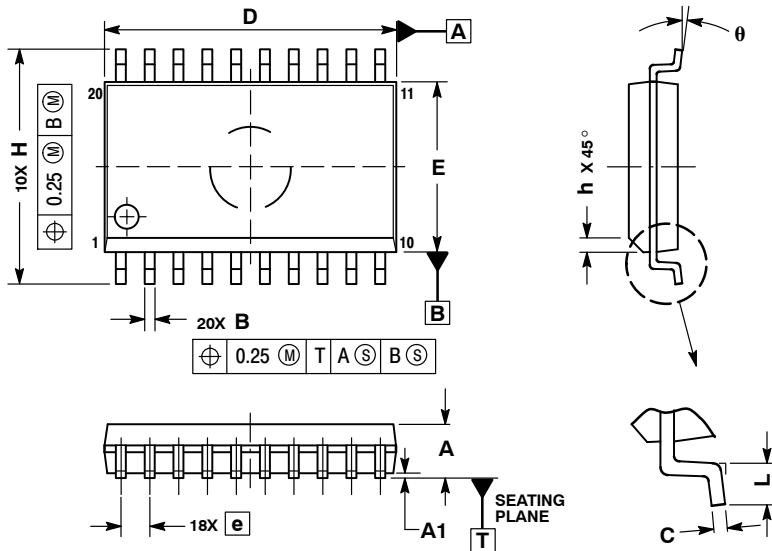

- NOTES:
1. DIMENSIONS ARE IN MILLIMETERS.
 2. INTERPRET DIMENSIONS AND TOLERANCES PER ASME Y14.5M, 1994.
 3. DIMENSIONS D AND E DO NOT INCLUDE MOLD PROTRUSION.
 4. MAXIMUM MOLD PROTRUSION 0.15 PER SIDE.
 5. DIMENSION B DOES NOT INCLUDE DAMBAR PROTRUSION. ALLOWABLE PROTRUSION SHALL BE 0.13 TOTAL IN EXCESS OF B DIMENSION AT MAXIMUM MATERIAL CONDITION.

| DIM | MILLIMETERS | |
|-------|-------------|-------|
| | MIN | MAX |
| A | 2.35 | 2.65 |
| A1 | 0.10 | 0.25 |
| B | 0.35 | 0.49 |
| C | 0.23 | 0.32 |
| D | 12.65 | 12.95 |
| E | 7.40 | 7.60 |
| e | 1.27 BSC | |
| H | 10.05 | 10.55 |
| h | 0.25 | 0.75 |
| L | 0.50 | 0.90 |
| theta | 0° | 7° |

MC74HCT245A

PACKAGE DIMENSIONS

TSSOP-20
DT SUFFIX
CASE 948E-02
ISSUE C

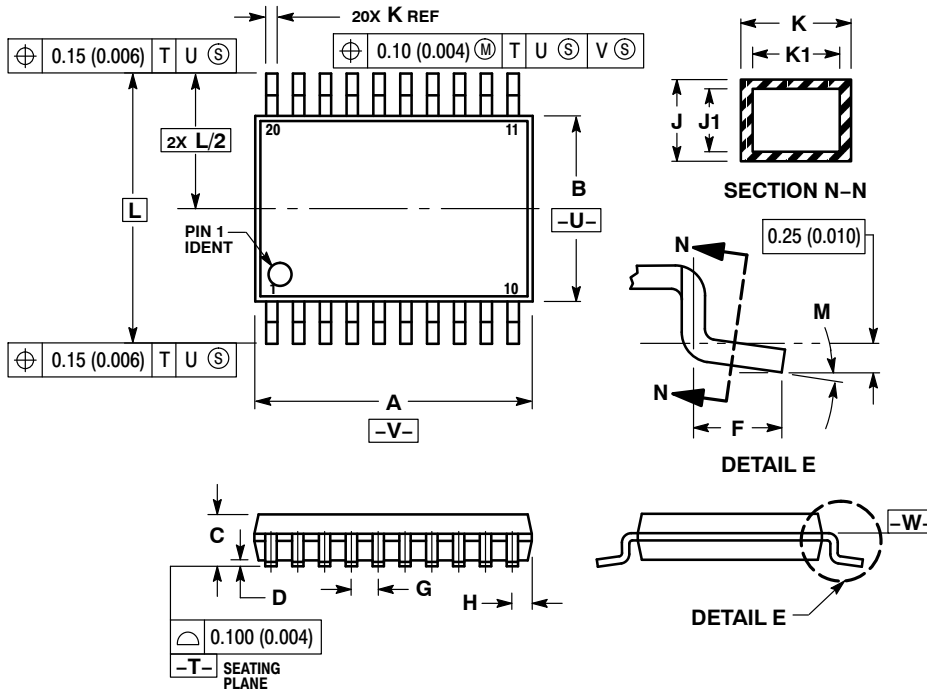

- NOTES:
1. DIMENSIONING AND TOLERANCING PER ANSI Y14.5M, 1982.
 2. CONTROLLING DIMENSION: MILLIMETER.
 3. DIMENSION A DOES NOT INCLUDE MOLD FLASH, PROTRUSIONS OR GATE BURRS. MOLD FLASH OR GATE BURRS SHALL NOT EXCEED 0.15 (0.006) PER SIDE.
 4. DIMENSION B DOES NOT INCLUDE INTERLEAD FLASH OR PROTRUSION. INTERLEAD FLASH OR PROTRUSION SHALL NOT EXCEED 0.25 (0.010) PER SIDE.
 5. DIMENSION K DOES NOT INCLUDE DAMBAR PROTRUSION. ALLOWABLE DAMBAR PROTRUSION SHALL BE 0.08 (0.003) TOTAL IN EXCESS OF THE K DIMENSION AT MAXIMUM MATERIAL CONDITION.
 6. TERMINAL NUMBERS ARE SHOWN FOR REFERENCE ONLY.
 7. DIMENSION A AND B ARE TO BE DETERMINED AT DATUM PLANE $-W-$.

| DIM | MILLIMETERS | | INCHES | |
|-----|-------------|------|-----------|-------|
| | MIN | MAX | MIN | MAX |
| A | 6.40 | 6.60 | 0.252 | 0.260 |
| B | 4.30 | 4.50 | 0.169 | 0.177 |
| C | --- | 1.20 | --- | 0.047 |
| D | 0.05 | 0.15 | 0.002 | 0.006 |
| F | 0.50 | 0.75 | 0.020 | 0.030 |
| G | 0.65 BSC | | 0.026 BSC | |
| H | 0.27 | 0.37 | 0.011 | 0.015 |
| J | 0.09 | 0.20 | 0.004 | 0.008 |
| J1 | 0.09 | 0.16 | 0.004 | 0.006 |
| K | 0.19 | 0.30 | 0.007 | 0.012 |
| K1 | 0.19 | 0.25 | 0.007 | 0.010 |
| L | 6.40 BSC | | 0.252 BSC | |
| M | 0° | 8° | 0° | 8° |

SOLDERING FOOTPRINT

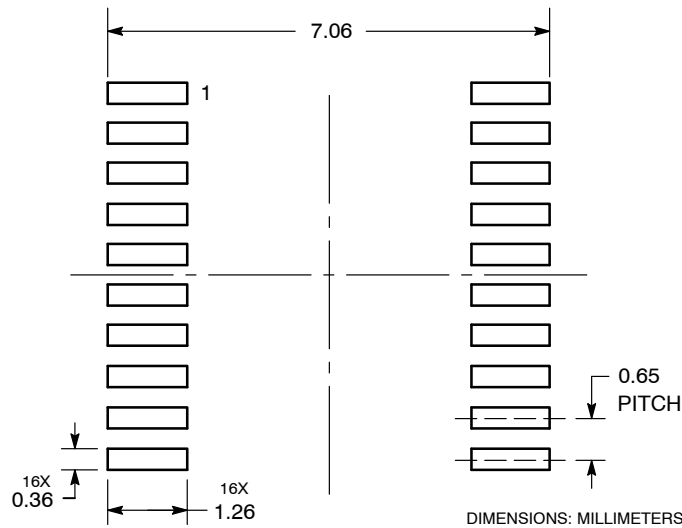

MC74HCT245A

PACKAGE DIMENSIONS

SOEIAJ-20
F SUFFIX
CASE 967-01
ISSUE A

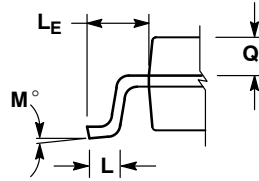
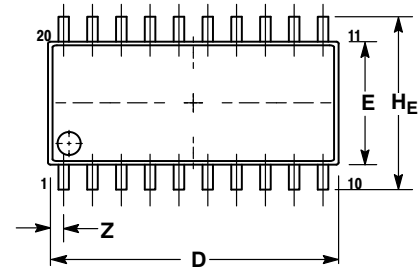

DETAIL P

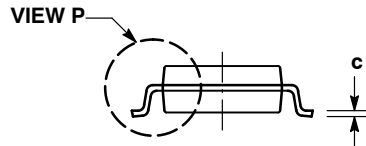
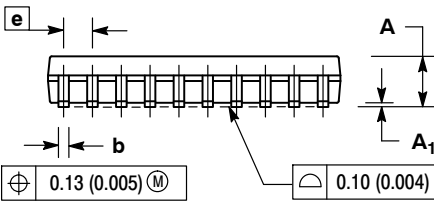

NOTES:

1. DIMENSIONING AND TOLERANCING PER ANSI Y14.5M, 1982.
2. CONTROLLING DIMENSION: MILLIMETER.
3. DIMENSIONS D AND E DO NOT INCLUDE MOLD FLASH OR PROTRUSIONS AND ARE MEASURED AT THE PARTING LINE. MOLD FLASH OR PROTRUSIONS SHALL NOT EXCEED 0.15 (0.006) PER SIDE.
4. TERMINAL NUMBERS ARE SHOWN FOR REFERENCE ONLY.
5. THE LEAD WIDTH DIMENSION (b) DOES NOT INCLUDE DAMBAR PROTRUSION. ALLOWABLE DAMBAR PROTRUSION SHALL BE 0.08 (0.003) TOTAL IN EXCESS OF THE LEAD WIDTH DIMENSION AT MAXIMUM MATERIAL CONDITION. DAMBAR CANNOT BE LOCATED ON THE LOWER RADIUS OR THE FOOT. MINIMUM SPACE BETWEEN PROTRUSIONS AND ADJACENT LEAD TO BE 0.46 (0.018).

| DIM | MILLIMETERS | | INCHES | |
|----------------|-------------|-------|-----------|-------|
| | MIN | MAX | MIN | MAX |
| A | --- | 2.05 | --- | 0.081 |
| A ₁ | 0.05 | 0.20 | 0.002 | 0.008 |
| b | 0.35 | 0.50 | 0.014 | 0.020 |
| c | 0.15 | 0.25 | 0.006 | 0.010 |
| D | 12.35 | 12.80 | 0.486 | 0.504 |
| E | 5.10 | 5.45 | 0.201 | 0.215 |
| e | 1.27 BSC | | 0.050 BSC | |
| H _E | 7.40 | 8.20 | 0.291 | 0.323 |
| L | 0.50 | 0.85 | 0.020 | 0.033 |
| L _E | 1.10 | 1.50 | 0.043 | 0.059 |
| M | 0° | 10° | 0° | 10° |
| Q ₁ | 0.70 | 0.90 | 0.028 | 0.035 |
| Z | --- | 0.81 | --- | 0.032 |

ON Semiconductor and are registered trademarks of Semiconductor Components Industries, LLC (SCILLC). SCILLC reserves the right to make changes without further notice to any products herein. SCILLC makes no warranty, representation or guarantee regarding the suitability of its products for any particular purpose, nor does SCILLC assume any liability arising out of the application or use of any product or circuit, and specifically disclaims any and all liability, including without limitation special, consequential or incidental damages. "Typical" parameters which may be provided in SCILLC data sheets and/or specifications can and do vary in different applications and actual performance may vary over time. All operating parameters, including "Typicals" must be validated for each customer application by customer's technical experts. SCILLC does not convey any license under its patent rights nor the rights of others. SCILLC products are not designed, intended, or authorized for use as components in systems intended for surgical implant into the body, or other applications intended to support or sustain life, or for any other application in which the failure of the SCILLC product could create a situation where personal injury or death may occur. Should Buyer purchase or use SCILLC products for any such unintended or unauthorized application, Buyer shall indemnify and hold SCILLC and its officers, employees, subsidiaries, affiliates, and distributors harmless against all claims, costs, damages, and expenses, and reasonable attorney fees arising out of, directly or indirectly, any claim of personal injury or death associated with such unintended or unauthorized use, even if such claim alleges that SCILLC was negligent regarding the design or manufacture of the part. SCILLC is an Equal Opportunity/Affirmative Action Employer. This literature is subject to all applicable copyright laws and is not for resale in any manner.

PUBLICATION ORDERING INFORMATION

LITERATURE FULFILLMENT:
Literature Distribution Center for ON Semiconductor
P.O. Box 5163, Denver, Colorado 80217 USA
Phone: 303-675-2175 or 800-344-3860 Toll Free USA/Canada
Fax: 303-675-2176 or 800-344-3867 Toll Free USA/Canada
Email: orderlit@onsemi.com

N. American Technical Support: 800-282-9855 Toll Free USA/Canada
Europe, Middle East and Africa Technical Support:
Phone: 421 33 790 2910
Japan Customer Focus Center
Phone: 81-3-5773-3850

ON Semiconductor Website: www.onsemi.com

Order Literature: <http://www.onsemi.com/orderlit>

For additional information, please contact your local Sales Representative